

User Manual

DEHUMIDIFIER

Noaton DF 4123 HEPA



Technical Specifications

Model	Noaton DF 4123 HEPA
Power Supply	220-240V~ 50Hz
Dehumidifying Capacity	23L/day(30°C RH80%)
	12L/day(27°C RH60%)
Power Consumption	240W
Air Flow	180m³/h
Water Tank Capacity	4.5L
Noise Level	≤46dB(A)
Operating Temperature	5~35°C
Refrigerant	R134a
Net Weight	14.5 kg
Product Size (WxDxH)	376 × 232 × 562 mm

The above technical data are for reference only. We reserve the right to modify them without notice.

Gavri s.r.o.
 Slunečná 6, Brno
 63400
 Czech republic
www.gavri.cz
www.noaton.cz

 **NOOTON**



Read operator manual. Before any use, refer to the corresponding section in this user manual.



Recycle unwanted materials instead of disposing of them. All appliances and packaging should be sorted and tendered at a regional recycling centre and be processed in an ecological manner.



The product conforms to the applicable European and other directives.

Trouble Shooting

Check the following before contacting technical support.

PROBLEM	POSSIBLE CAUSE	SOLUTION
The device does not work	The power is not connected	Insert the plug into the wall outlet
	The water tank is full	Empty the tank
	The tank has not been replaced correctly	Replace the tank
Water removal capacity is too low	Runtime is too short	Be patient and wait
	Ambient temperature or humidity is too low	It is normal that the device does not dehumidify in these conditions
The device works, but reduces the relative humidity insufficiently	The room is too big	We recommend using a dehumidifier with a greater capacity
	There is too much ventilation	Reduce ventilation (e.g. close windows and shut doors)
	The air filter is clogged	Clean the air filter
	Set humidity is higher than the ambient humidity	Set the humidity lower than ambient humidity
Dehumidifier is blowing out warm air	The dried air is passed over heating coils before it is blown into the room as part of the dehumidifying process	This is normal, a dehumidifier is not an air cooler
The display is not showing the humidity set point	The display shows the room relative humidity not the set point	Press the up or down button once to see the target relative humidity
Water on floor	There is residual water in tank, and the device is lurched too much by moving	Be careful when move the tank
The dehumidifier is noisy	The air filter is blocked or the device is on an uneven surface	Clean the filter or put the device on a flat surface

Figure1

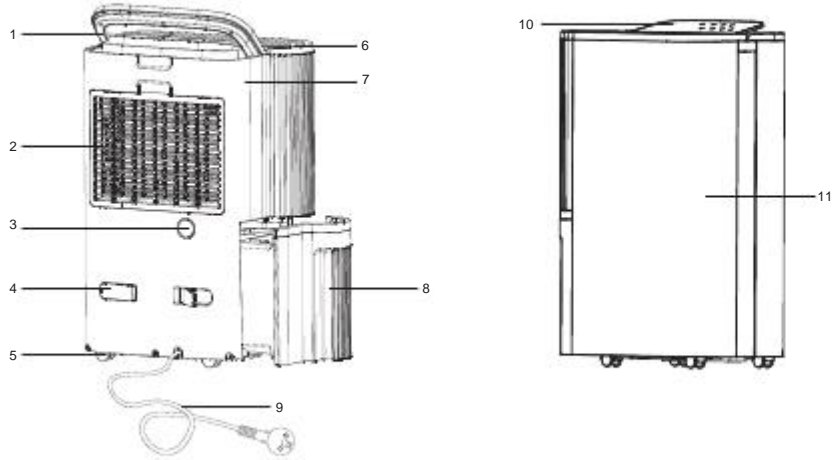

Figure2

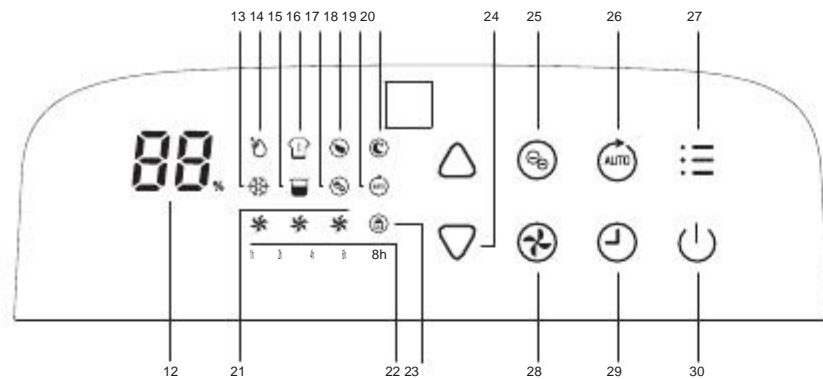
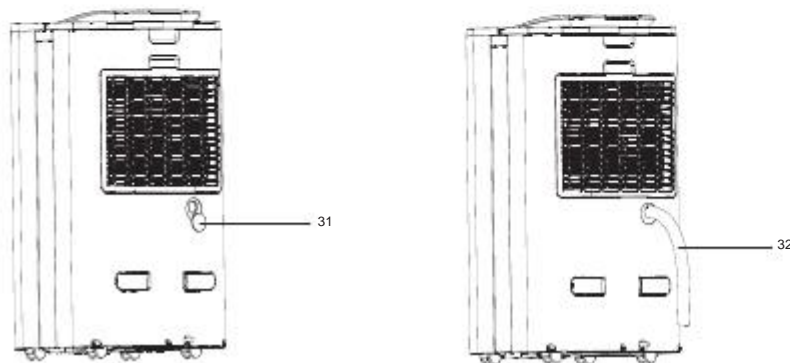

Figure3



Storage

If the dehumidifier will not be used for a long period of time, take the following steps:

1. Remove the plug from the socket and empty the tank, make the tank and the dehumidifier dry completely, this may take a couple of days.
2. Clean the air filter .
3. Check the dehumidifier for perfect condition to ensure a safe use of it after a long period of storage.
4. Pack the device with the suitable packaging.
5. Store the dehumidifier in a dust-free and out of direct sunlight location, preferably covered with a sheet of plastic.

Display Error Codes

Please contact local distributor if any of the error codes below appears.

Display Code	E1	E2
Error	Temperature sensor error	Humidity sensor error
Display	Flash every 30 seconds	Flash every 30 seconds
What is happening	Device still dehumidifies but is in defrost mode only.	Device still dehumidifies but is in continuous dehumidifying mode only.

Product Description

Components

1. Handle
2. Air Inlet Grille
3. Drainage Outlet
4. Power Cord Bracket
5. Castors
6. Air Outlet
7. Rear Cover
8. Water Tank
9. Power Cord
10. Control Panel
11. Front Cover

Control Panel

12. Humidity Reading
13. Defrost Indicator
14. Manual Dehumidifying Indicator
15. Tank Full Indicator
16. Laundry Drying Indicator
17. Anion Indicator
18. Air Purifying Indicator
19. Auto Indicator
20. Sleep Indicator
21. Fan Speed Indicators
22. Time Indicators
23. Child Lock Indicator
24. Up And Down Buttons
25. Anion Button
26. Auto Button
27. Mode Button
28. Fan Speed Button
29. Timer Off Button
30. Power Button

Drainage

31. Drainage Outlet Plug
32. Drainage Pipe

Cleaning

When used regularly, the filter may become clogged with dust and particles. Therefore the filter should be cleaned at least every two weeks. Follow these steps:

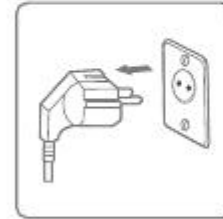

1. Switch the device off and remove the plug from the socket before cleaning.



2. Clean the housing with soft, dry cloth. If the device is extremely dirty, use a mild cleaning agent. Wipe the dehumidifier with a slightly damp cloth. Never spray the device with water.



3. Remove the filter, clean the filter with a vacuum cleaner or soapy water no hotter than 40°C.

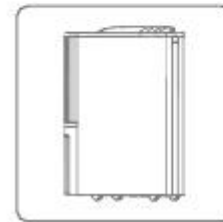

4. Rinse and dry the filter completely before installing back to the device.

Table of Contents

Safety Instructions	1-2
Prior to Operation	3
Continuous Drainage	3
Operation Instructions	4-8
Cleaning	9
Storage	10
Display Error Codes	10
Trouble Shooting	11
Technical Specifications	12

Operation Instructions

Auto Shut off with Water Tank Full Indicator



The unit will go into standby mode when water tank is full or the water tank is not installed properly. After emptying the tank or install the water tank properly, the unit will go on to the previous mode.

Except for the power button, all other buttons are invalid.

Memory Function:

- When unplugged directly or power cut, then reconnected to the power supply, the dehumidifier will run with the mode prior to the shutdown. The timer setting will be kept.
- Press the power button to switch off the dehumidifier, and then press the power button to switch it back on. The dehumidifier will run with the mode prior to the shutdown. The timer setting will be canceled.
- Switch off the device and unplug the power cord, then reconnect the power supply and switch on the dehumidifier. It will run as factory preset mode the first time you received the dehumidifier.

Safety Instructions

Warning

This appliance is intended for use in a domestic environment only. Any other use is not recommended by the manufacturer and may cause fire, electrical shocks or other person injury or property damage.



Cautions



Wet hands not allowed



Warning

Power Cord



Do not pull the power cord in order to unplug the device from the socket.



Do not use the appliance in overloaded extension cord.

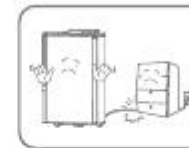

Do not put any heavy objects on the power cord in order to avoid safety hazard.



Do not use the appliance if its socket holes cannot firmly hold a plug.



Do not attempt to change the power cord, contact the authorized service centre for repair.



Do not touch the plug with wet hands in order to avoid electric shock.

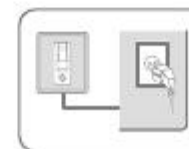

The socket has to be earthed and appropriately secured.



Please pull out the plug during lightning storms.

Safety Instructions

Placement



Do not put flammable and explosive objects around the appliance in order to avoid fire.



Do not use the appliance in swimming pool or similar facilities in order to avoid safety hazard.



Do not use the appliance in a draughty place.



Place the appliance on a stable, flat surface.

During Use

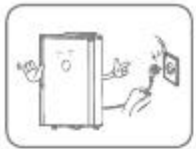

Please turn off the power and unplug the power cord before moving it.

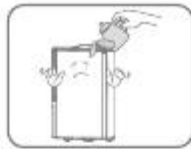

Do not pour the water into the appliance in order to avoid malfunction.

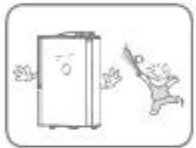

Children should be supervised to ensure that they do not place stick into the appliance.

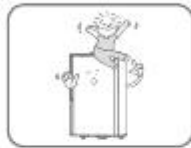

Do not put any heavy objects on the appliance in order to avoid malfunction.



Do not push the appliance over or let the appliance suffer strong impact in order to avoid malfunction.

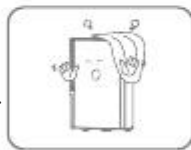

The appliance must not be covered when being used.



Do not put hands on the air outlet in order to avoid injury or malfunction.

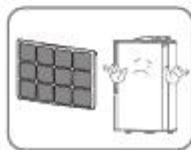

Please install the air filter before using it.

Operation Instructions

• Manual Mode



Press the mode button 4 times to select Manual mode, the unit runs by default continuous dehumidifying with medium fan speed.

At manual mode all buttons are valid.

Safety Childlock Function [Fan Speed button-2 seconds]



Press the fan speed button for 2s to lock all the buttons with a beeping sound, the same operation can unlock it.

Safety childlock function can be set at standby mode and working mode.

Low Temperature Defrost Mode



When the ambient temperature is too low, dehumidifier will enter into the defrost mode, the unit runs with high fan speed without dehumidifying.

Fan speed button is invalid.

Operation Instructions

Multifunction Optional [Mode button]

• Laundry Drying Mode

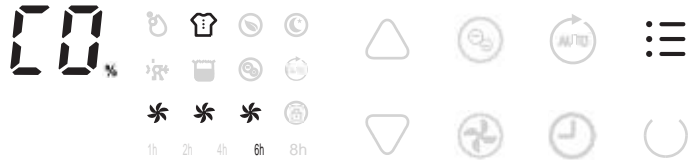

Press the mode button once to select Laundry Drying mode, the unit runs in continuous dehumidification with high fan speed for 6 hours then switch off automatically.

🗨️ Fan speed button and timer button are invalid.

• Air Purifying Mode

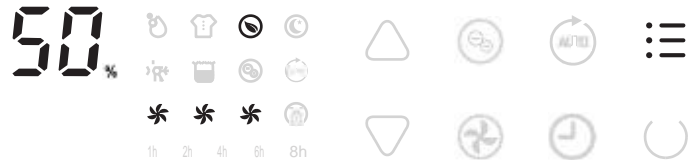

Press the mode button 2 times to select Air Purifying mode, the unit runs with high fan speed without dehumidifying.

🗨️ Fan speed button is valid.

• Sleep Mode



Press the mode button 3 times to select Sleep mode, the unit runs with a designated humidity setting of 55% along with low fan speed. All indicators will be off 5s after the setting is completed. Touch any button to activate the light, and to operate as usual.

🗨️ Fan speed button is valid.

🗨️ With no further operation after activate the light for 30s, lights will be off again.

🗨️ When the water tank is full on sleep mode, water tank full indicator will always be on.

Prior to Operation

- Place the dehumidifier in an upright position on a stable, flat surface.
- Ensure the dehumidifier is at a safe distance at least 50cm away from a wall or furniture.
- Supply power should be in correspondence with the value on the nameplate, power outlet needs to be grounded.
- Ensure the tank is correctly fitted, if the tank is full or not in place, the tank full light comes on and the dehumidifier will stop working.

Continuous Drainage

In general, water will be collected by tank, if you want continuous drainage, please do steps as follows:

(refer to figure 3)

1. Unplug the drainage outlet plug.
2. Insert the drainage pipe with 13mm inner diameter into water outlet.

Please always make sure the pipe is going downhill, is not blocked or kinked.

Operation Instructions

Connect the power plug to the correct power supply; all indicators and buttons will light up and then will be off.

Desired setting will be confirmed 3s after the operation.

Switch On / Switch Off The Unit [Power button]



Press the power button once to turn on the unit, the unit runs by default mode on manual continuous dehumidifying with medium fan speed.

Press the power button to turn off the unit, it will stop working, fan will work for some seconds to blow out the hot air inside the unit.

Auto Shut-off Timer Function [Timer button]



Press the timer button to select your preferred timer hour from 1h-2h-4h-6h-8h-cancel for automatic shutoff by each press.

Auto timer off setting will be canceled if press timer button for 2 times in 3 seconds.

Auto timer off setting will be canceled if switch off the unit and switch on again.

Fan Speed Option [Fan Speed button]



Press the fan speed button to select your preferred fan speed setting of low, medium and high to meet the different usage requirements.

Fan speed button is invalid at laundry drying mode, auto mode and defrost mode.

Operation Instructions

Humidity Setting [Up and Down buttons]



Press the up/down buttons to select your preferred humidity from CO-30%-35%-40%-45%-50%-55%-60%-65%-70%-75%-80%-CO. CO means continuous dehumidifying regardless of ambient humidity.

Anion Function [Anion button]

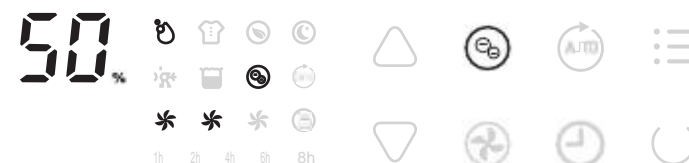

Press the anion button to activate the anion function to fresh up the air quality.

Anion function will be off automatically when the fan stops working.

Auto Dehumidifying Function [Auto button]



Press the auto button to select the auto dehumidifying mode, the unit runs automatically accordance to the ambient humidity detected below.

Ambient RH% detected	Compressor	Fan Speed Level
RH% > 65%	Working	High
55 ≤ RH% ≤ 65	Working	Medium
RH% < 55%	Stop working	Low

Fan speed button and up/down buttons are invalid.